

22400925

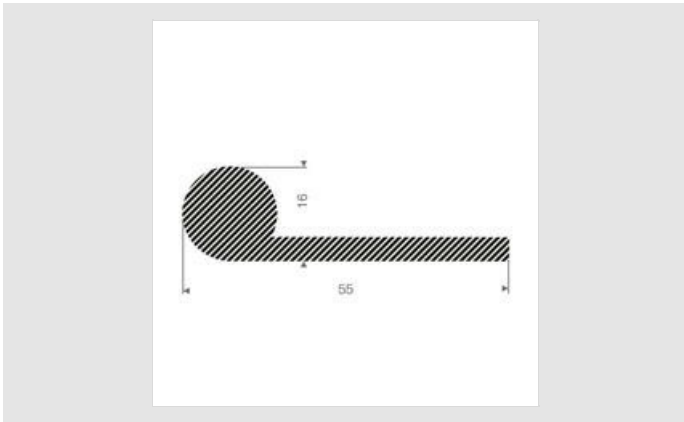

Qualité	EPDM
Dureté	15° Shore A \pm 5°
Tolérances	ISO 3302 E3
Epaisseur	16,00mm
Largeur	55mm
Longueur	25000mm
Coloris	Noir

Application:

Commercial Vehicles - Construction - Interior Design -
Machine Manufacturers - Marine Solutions